



## ABC-95 95" BOTTLE COOLER

INCLUDE 3 YEAR PARTS + LABOR / 5 YEAR COMPRESSOR WARRANTY

### Dimensions

Exterior Dimensions (WxDxH)	94.96" x 28.46" x 33.43"
Interior Dimensions (WxDxH)	
Weight	302 lbs
Packaging Dimensions (WxDxH)	
Capacity Cans	1,893
Capacity Bottles	877
Capacity (L)	886

### Cooling

Temperature Range	32° - 41° F
Refrigerant	R290
Maximum Ambient	95° F
Temperature Rating	N Class
Defrosting	Automatic
Temperature Display	No
Temperature Controller	Thermostat
H/P	3/8

### Construction

Exterior Material	EGI(Electro Galvanized Iron) + Black Embossed Painting
Insulation Material	Cyclopentane
Shelf Material	SWRM-B + PE Coating
Shelf Load Capacity	Divide
# Shelves	5

### Electrical

Voltage	115
Amps	3.5A
Hz	60
Phase	10

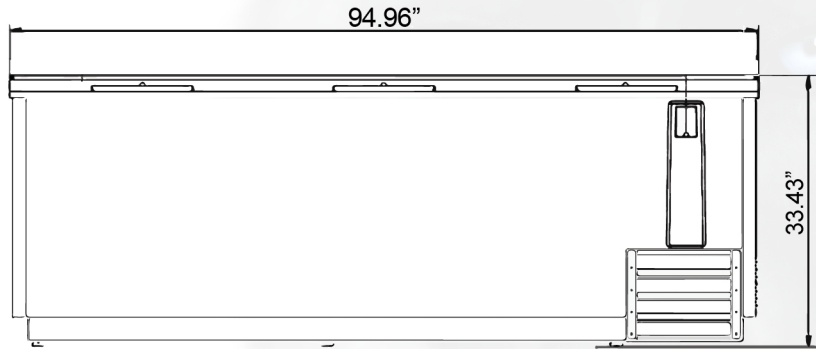

Front View

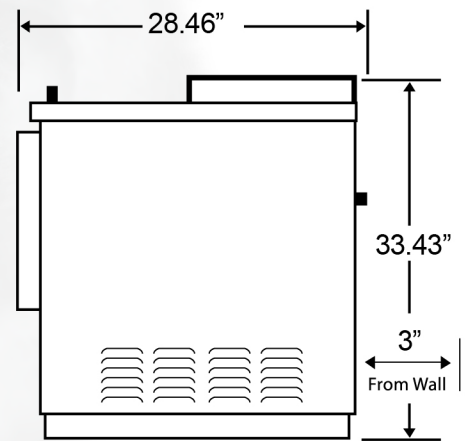

Side View

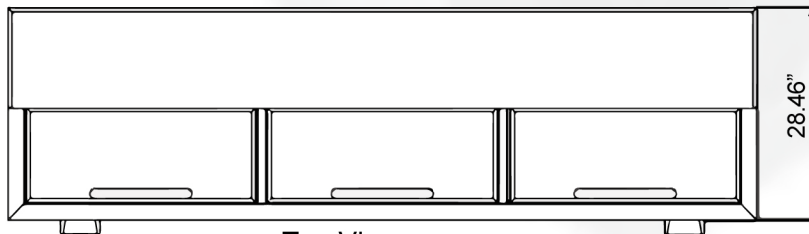

Top View



Intertek